



ASI071 Manual

Revision 1.3

Mar, 2018

All materials related to this publication are subject to change without notice and its copyright totally belongs to Suzhou ZWO CO.,LTD.



Table of Contents

ASI071 Manual	1
1. Instruction	3
2. What's in the box?.....	4
3. Camera technical specifications.....	5
4. QE Graph & Read Noise.....	6
5. Getting to know your camera.....	8
5.1 External View.....	8
5.2 Power consumption.....	9
5.2 DDR Buffer.....	9
5.3 Cooling system.....	10
5.4 Back focus distance.....	10
5.5 Protect Window.....	10
5.6 Analog to Digital Converter (ADC).....	11
5.7 Binning.....	11
5.8 Tilt adjustment.....	11
6. How to use your camera.....	12
7. Cleaning	13
8. Mechanical drawing.....	15
9. Servicing	15
10. Warranty	15



1. Instruction

Congratulations and thank you for buying one of our ASI Cameras! This manual will give you a brief introduction to your ASI camera. Please take the time to read it thoroughly and if you have any other questions, feel free to contact us. info@zwoptical.com

ASI071 Camera is designed for astronomical photography. This is our first APS-C format CMOS camera which is not only suitable for DSO imaging, but also for other kind of astronomical imaging. The excellent performance and multifunctional usage will impress you a lot!

Model	Mono or Color	Regulated TEC Cooling	Sensor
ASI071MC Pro	Color	Yes	SONY IMX071 CMOS
ASI071MC-COOL discontinue	Color	Yes	SONY IMX071 CMOS

For software installation instructions and other technical information please refer to “ASI USB3.0 Cameras software Manual”

<https://astronomy-imaging-camera.com/>

2. What's in the box?

ASI071MC Pro



camera bag



camera body



M42-M48 adapter



quick guide



USB3.0 cable



21mm extender



T2-M48
16.5mm extender



2" cover



hexagon wrench



0.5m USB 2.0 cable X2

3. Camera technical specifications

Sensor	SONY IMX071 CMOS
Diagonal	28.4mm
Resolution	16 Mega Pixels 4944X3284
Pixel Size	4.78 μ m
Image area	23.6mmX15.6mm
Max FPS at full resolution	10FPS
Shutter	Rolling shutter
Exposure Range	64 μ s-2000s
Read Noise	2.3e @24db gain
QE peak	TBD
Full well	46k e
ADC	14 bit
DDRIII buffer	256MB
Interface	USB3.0/USB2.0
Adapters	M42X0.75
Protect window	AR window
Dimensions	86mm Diameter
Weight	640g
Back Focus Distance	17.5mm
Cooling:	Regulated Two Stage TEC
Delta T	35°C -40°C below ambient
Cooling Power consumption	12V at 2A Max
Supported OS	Windows, Linux & Mac OSX
Working Temperature	-5°C~45°C
Storage Temperature	-20°C~60°C
Working Relative Humidity	20%~80%
Storage Relative Humidity	20%~95%

4. QE Graph & Read Noise

QE and Read noise are the most important parts to measure the performance of a camera. Higher QE and Lower read noise are needed to improve the SNR of an image. Here is the relative QE graph of ASI071.

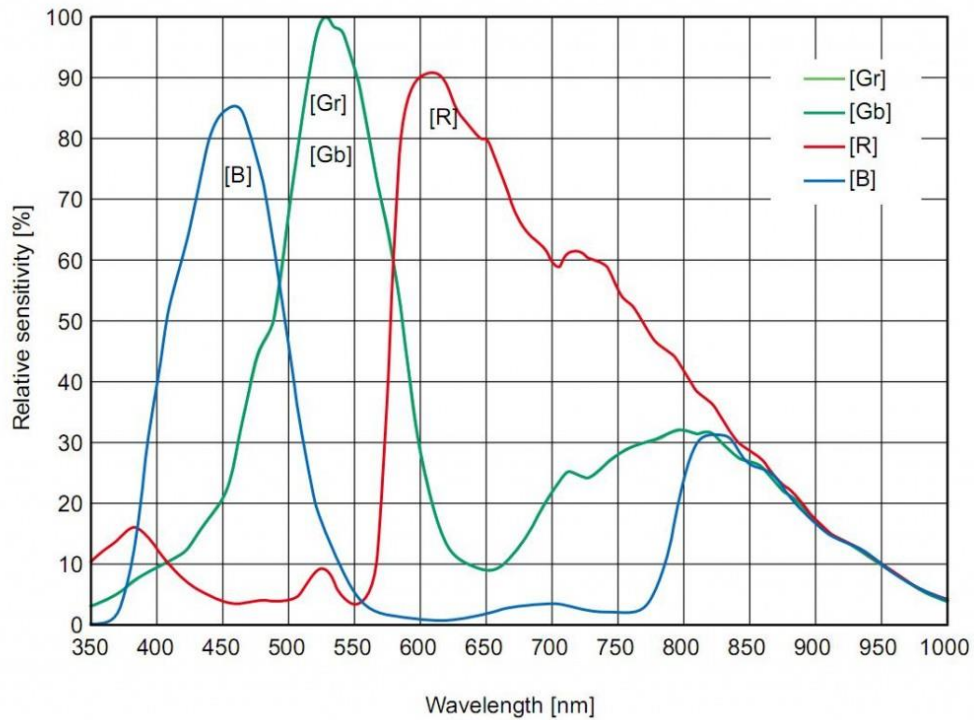

Read noise includes pixel diode noise, circuit noise and ADC quantization error noise, and the lower the better.

The Read Noise of the ASI071 cameras is extremely low when compared with traditional CCD cameras and it is even lower when the camera is used at a higher gain.

Depending on your target, you can set the gain lower for higher dynamic range (longer exposure) or set the gain higher for lower noise (such as short exposure or lucky imaging).

Read noise, full well, gain and dynamic range for ASI071 Pro

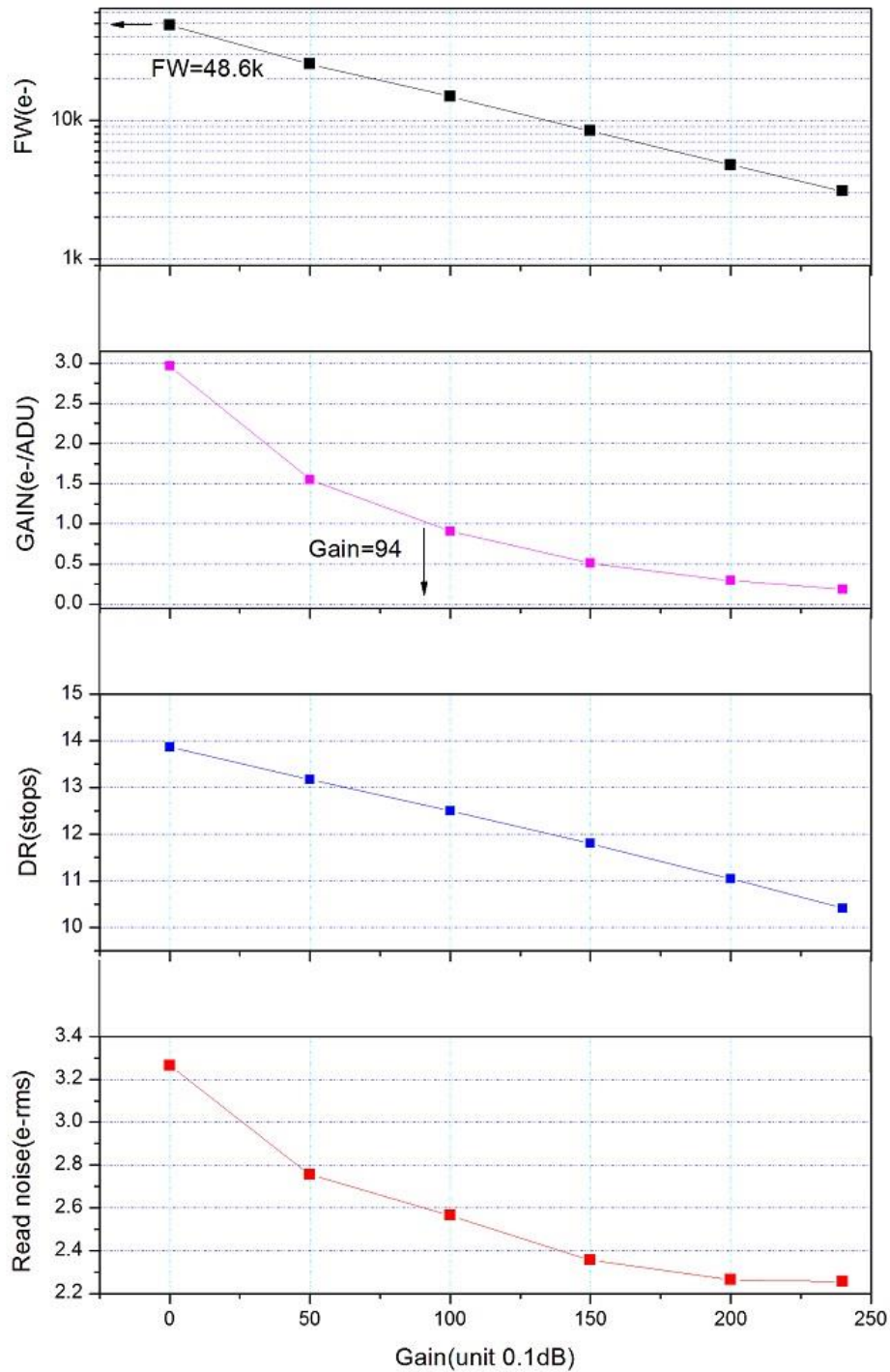

5. Getting to know your camera

5.1 External View

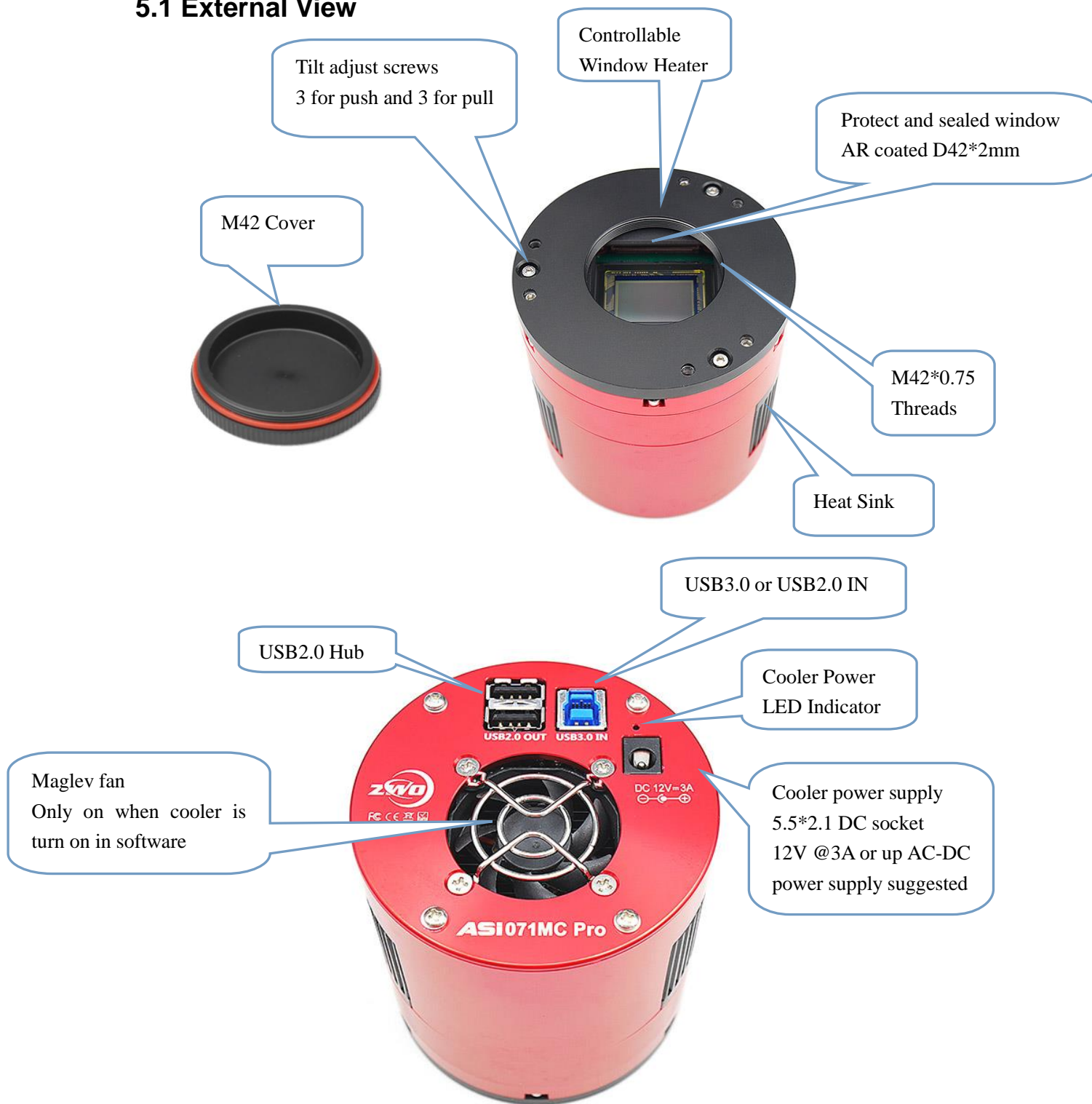

5.2 Power consumption

ASI071 has one APS-C format sensor, the max power consumption is around 500ma@5V which is nearly the maximum power supply of USB2.0. We recommend customer connect ASI071 through USB3.0 which can provide 1A@5V power. You also need a separate power supply to power the cooler. We recommend using a 12V/3-5A or more DC adapter for cooler power supply (2.1×5.5, center positive). Using a battery with 9-15V is also suitable for the cooler power supply. ASI071 and USB hub is powered from 12V DC power supply if you connect it.

Here is a test result of the cooler power consumption of ASI071 camera. It only needs 0.5A to cool the camera to 30°C below ambient.

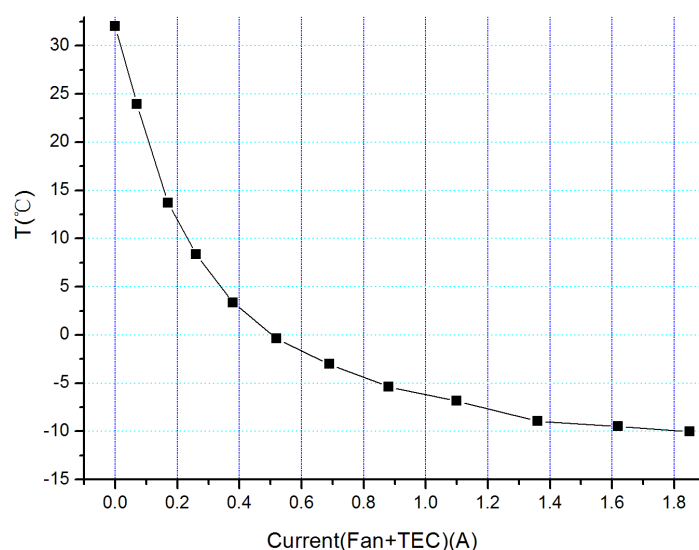

5.2 DDR Buffer

ASI294 Pro camera includes one 256MB DDR3 memory buffer to help data transfer more stable and no amp-glow issue which is caused by the slow speed data transfer during reading out under USB2.0 Port.

DDR memory buffer is the main difference between ASI “Cool” and “Pro” cameras.

5.3 Cooling system

The ASI071 camera has a robust, regulated cooling system, which means that the camera sensor can be kept at the desired temperature throughout your imaging session. The super low readout noise, combined with efficient cooling and adjustable gain setting, allows you to do short or lucky DSO imaging unlike the traditional CCD cameras which need very long exposure for each frame. However, keep in mind that cooling won't help with very short exposure such as less than 100ms. The lowest temperature that can be set is -35°C ~ -40°C below ambient.

Here is a dark current test result of ASI071 sensor at various temperatures.

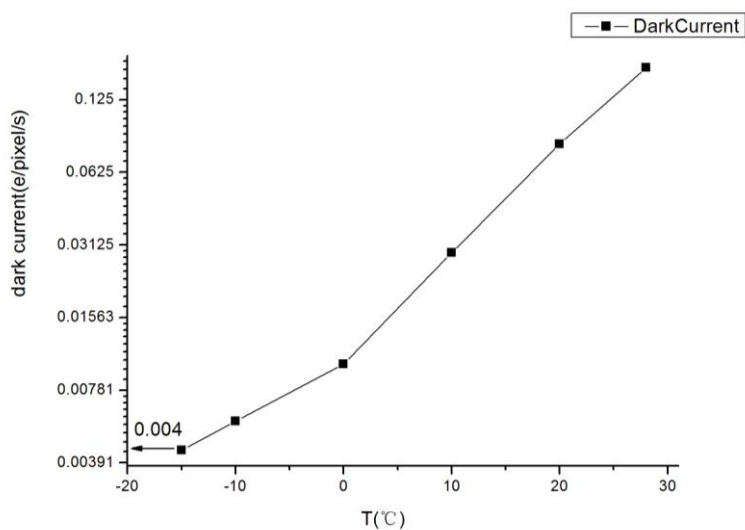

5.4 Back focus distance

The M42 female flange to the sensor is 17.5mm. You can reach 55mm back focus distance with the 21mm and 16.5mm extender included in the camera package.

5.5 Protect Window

There is a protect window before the sensor of ASI071 camera.

It's an AR-AR coated BK7 glass, diameter is 42mm and 2mm thick.

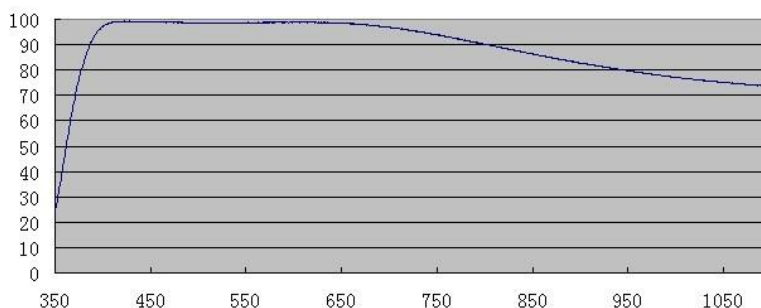

5.6 Analog to Digital Converter (ADC)

The ASI071 camera records in 14bit ADC. This camera also supports ROI (region of interest) imaging, and smaller ROI has faster fps.

Here is the maximum speed of ASI071 running under USB2.0 and USB3.0.

Resolution	USB 2.0	USB3.0
	14Bit ADC	14Bit ADC
4944×3284	2.7fps	10fps
1920×1200	18.8fps	28fps
1280×1080	31.3fps	33fps
640×480	69.5fps	70fps
320×240	134.2fps	134fps

5.7 Binning

The ASI071 camera supports hardware bin3 and software bin2, bin3 and bin4 mode. Hardware binning is supported by sensor but is done in digital domain like software binning and use 10bit ADC. The only advantage of hardware binning is faster fps (20fps). We recommend customer to use software binning if you don't need faster fps. Just set "hardware binning" on in software to enable hardware binning.

5.8 Tilt adjustment

The alignment of sensor just like align the primary mirror of newtonian.

There is 3 directions you can adjust, each direction have one push and pull screws.



6. How to use your camera

There are many adapters available for this camera for connecting to your scope or lens. Some are included with the camera and others you can order from our official website:

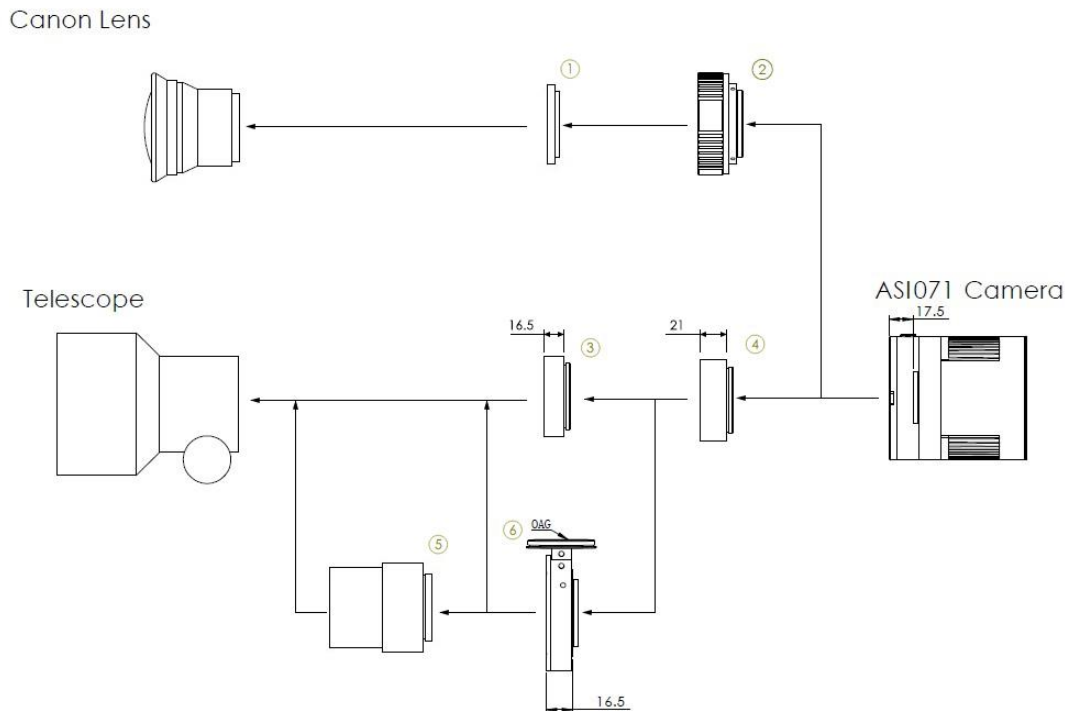

1. 2" Filter (optional)
2. EOS-T2 adapter
3. M42 to M48 extender 16.5mm
4. M42 extender 21mm
5. Focal reducer
6. OAG (16.5mm thickness)



7. Cleaning

The camera is sealed and comes with an AR protect window to protect the sensor from dusts and humidity. We don't recommend customer to open the camera for cleaning. The dusts can be removed by post processing with flat frame.

To see the dusts, you just need to set up your telescope and point it to a bright place. A Barlow is required to see these dusts clearly. Then attach the camera and adjust the exposure to make sure not overly exposed. You can see an image like below if it's dirty.

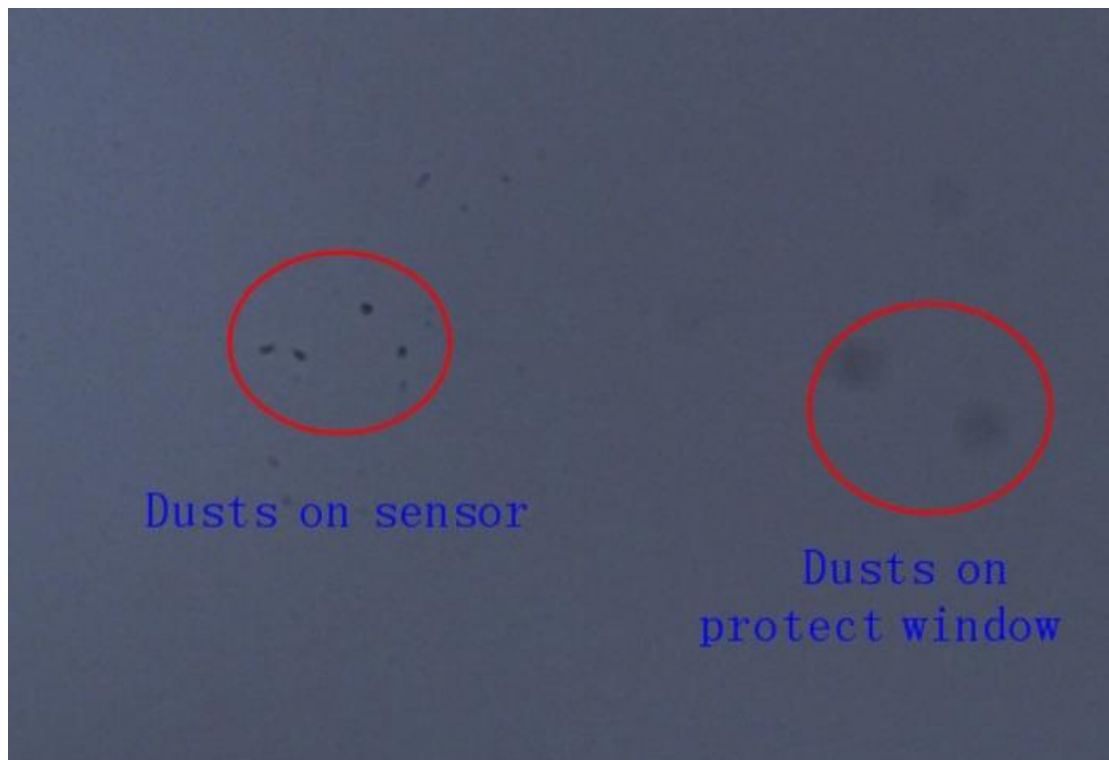

The big dim spot on the image (at right) are the shadows of dust on the protect window.

The very small but very dark spot in the image (at left) are the shadows of the dusts on the sensor.

The suggested way to clean them is try to blow them away with a manual air pump. To clean the dust on the sensor you will need to open the camera chamber.

We have a very detailed instruction on our website:

<https://astronomy-imaging-camera.com/manuals/>

Quickguide

- [ZWO ASI Camera Quick Guide](#)
- [ZWO ASI Cooled Camera Quick Guide](#)
- [How to clean ASI camera and redry the desiccant](#)

8. Mechanical drawing

ASI071MC Pro

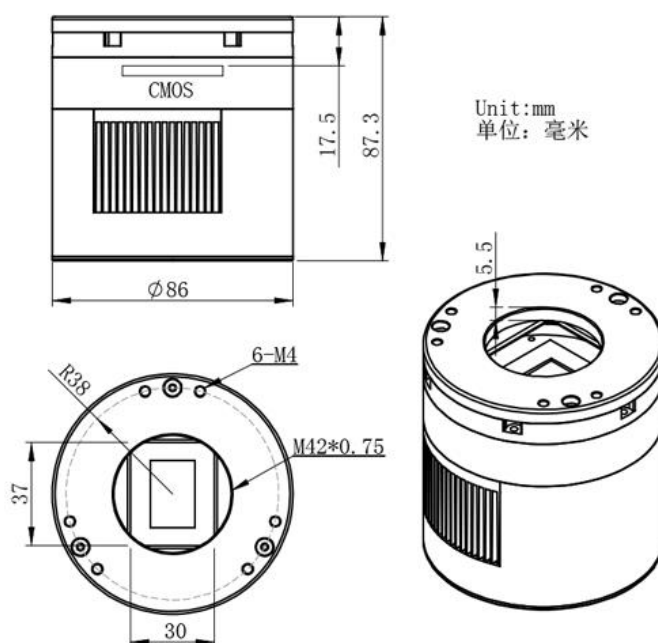

9. Servicing

For software upgrades please refer to “Support-manual and software” on our official website.

<https://astronomy-imaging-camera.com/>

Repairs and servicing are available by emailing info@zwoptical.com

For customers who bought the camera from your local dealer, dealer is responsible for the customer service.

10. Warranty

We provide 2-year warranty for our products. We offer repair service or replacement for free if the camera doesn't work within warranty period.

After the warranty period, we continue to provide repair support and service on a charged basis. This warranty does not apply to damage that occurred as a result of abuse or misuse, or caused by a fall or any other transportation failures after purchase.

Customer must pay for shipping when shipping the camera back for repair or replacement.